

BUILT IN AUTOMATIC
COFFEE MACHINE
WITH PORTAFILTER

Manual of installation, use and maintenance

1 SAFETY INSTRUCTIONS AND PRECAUTIONS	2
Usage safety.....	2
Technical safety.....	3
Correct use.....	3
2 INSTALLATION	4
3 DESCRIPTION AND OPERATION	6
Technical data.....	6
Front view and overall view.....	6
Control buttons and display panel.....	6
4 IMPORTANT INSTRUCTIONS FOR USE	7
Switch-on.....	7
Filling the water tank.....	7
Filling the coffee bean container.....	7
Setting 1 or 2 coffees.....	8
Selecting the type of espresso.....	8
Preheating.....	8
Adjusting the espresso dose.....	8
Preparing cappuccino.....	8
Steam.....	8
Water.....	8
Deactivate Steam and water (child lock).....	8
Coffee beans.....	9
Ground coffee.....	9
Single serving pods.....	10
Compatible coffee capsules.....	10
5 OPERATION AND USE	11
Programming the machine.....	11
6 CARE AND CLEANING	12
Water tank.....	12
Steam dispenser.....	12
7 DESCALING THE MACHINE	13
8 TROUBLE-SHOOTING	13
9 DISPOSAL OF ELECTRICAL APPLIANCES	14

1 SAFETY INSTRUCTIONS AND WARNINGS

This machine complies with the safety regulations currently in force. Incorrect use of the machine may lead to personal injury and damage to objects. Please read all the instructions carefully before using the machine as they contain important information on safety and the use and maintenance of the machine. This will protect you and prevent damage to the machine.

USAGE SAFETY

Warning! Danger of burning! The liquids that come out of the dispensers are extremely hot!

- This appliance can be used by children aged from 8 years and above if they have been given supervision or instruction concerning use of the appliance in a safe way and if they understand the hazards involved.
- Cleaning and user maintenance shall not be made by children unless they are older than 8 and supervised.
- Keep the appliance and its cord out of reach of children aged less than 8 years.
- Children's skin is more sensitive to high temperatures. **Danger of burning!**
- Remember, too, that espresso coffee is not a suitable beverage for children.
- Appliances can be used by persons with reduced physical, sensory or mental capabilities or lack of experience and knowledge if they have been given supervision or instruction concerning use of the appliance in a safe way and understand the hazards involved.
- Children shall not play with the appliance.
- **Danger of suffocation.** Packaging, e.g. plastic wrappings, must be kept out of the reach of babies and children. Whilst playing, children could become entangled in packaging or pull it over their head and suffocate.
- This appliance is intended to be used in household and similar applications such as: – staff kitchen areas in shops, offices and other working environments; – farm houses; – by clients in hotels, motels and other residential type environments;

– bed and breakfast type environments.

- The first time the machine is put into operation, it is necessary to rinse the pipes to eliminate any deposits and to ensure hygiene.

- Fill the water tank only with room temperature or cold drinkable water. Hot or boiling water or any other liquid can damage the operation of the machine. We recommend changing the water daily to prevent the germ proliferation.

- Place only whole coffee beans in the coffee container. Ground coffee poured into the container can damage the operation of the grinder.

- **Sugar damages the machine!**

Never use coffee beans that are treated with caramel, sugar, or other similar substances, instant coffee, or any substances containing sugar.

- Boiling water and steam can cause burning; therefore, please use these functions with the utmost attention. Do not turn the steam dispenser towards any parts of your body. **Danger of burning!**

- Always make sure that the steam selector is disengaged when steam is not needed. Otherwise, steam could be dispensed inadvertently. **Danger of burning!**

- The steam dispenser becomes very hot during use. Grasp the dispenser only by the coupling. **Danger of burning!**

- Depending on the lime content of the water, the machine should be descaled regularly. In zones where the water is very hard, it will be necessary to descale the water pipes more often. Follow the mixture ratio indicated on the package of the descaling product; otherwise the machine could be damaged.

- Do not put weight on the open drawer of the coffee machine, as this could damage the machine.

The manufacturer declines all responsibility for any damage caused by failure to follow the safety instructions and precautions.

TECHNICAL SAFETY

- Before connecting the machine to the power mains, check carefully to make sure that the voltage and frequency ratings shown on the rating plate correspond to those of the electrical system. These values must absolutely correspond in order to avoid damage to the machine. In case of doubt, contact a qualified electrician.
- The electrical safety of the machine is guaranteed only if it is connected to a standard earth conductor. It is very important to verify this information with the utmost attention, and in case of doubt have the electrical system checked by a qualified electrician. The manufacturer declines all responsibility for any damage caused to people or things due to the lack or malfunction of the earth conductor (for example: risk of electrocution).
- Put the machine into operation only after complete installation in order to avoid contact with the electrical components. Before carrying out assembly, disassembly, or daily maintenance of the machine, always make sure to disconnect the power cable from the electrical outlet.
- The connection of the machine to the power mains must not be made using extension cables, as they do not guarantee the necessary safety of the machine (for example: risk of overheating).
- The machine can also be flush-mounted in a wall unit (special accessory). It is not suitable for outdoor use. Considering the heavy weight of the machine, it is essential for the unit to be adequately secured to the adjacent wall.
- If the power cable is damaged, it must be replaced by the manufacturer, its technical service, or by a qualified electrician, in order to prevent any risk.
- All installation, maintenance, and repair operations must be carried out by qualified personnel only. Incorrect installation, maintenance, and repairs may lead to serious dangers to the user, for which the manufacturer declines all responsibility.
- The machine is disconnected from the power mains only when:

- the main switch of the electrical system is switched off;
- the fuse of the home electrical system is completely disconnected;
- the power plug of the machine is completely removed from the electrical outlet.

- To disconnect the machine from the power mains, grasp the plug and remove; do not pull on the power cable.

- Do not open the machine casing for any reason. Touching the voltage cables or modifying the electrical or mechanical structure may lead to electrocution. This could also cause disturbance in the operation of the machine. The manufacturer declines all responsibility towards persons or things due to failure to observe the instructions above.

- In the event that the machine has to be installed in combination with another appliance, it must be separated from the other appliance by a solid intermediate shelf.

CORRECT USE

This machine is designed solely for preparing espresso (short, medium or long) and cappuccino. Other types of use are not permitted and may prove dangerous.

The manufacturer will not be held liable for any damage caused by incorrect use of the machine.

Please put only fresh coffee beans into the tank to get the best aroma. The beans can remain in the grinder and only require grinding when needed.



The coffee dispenser has to be used with ground coffee, single serving pods, capsules for the preparation of espresso coffee, cappuccino, tea and more.

2 INSTALLATION

IMPORTANT NOTE

The installation of the appliance must be carried out exclusively by qualified personnel in compliance with the regulations in force. Considering the heavy weight of the machine, it is essential that the furniture unit be suitably secured to the wall.

- Check to make sure that the opening for housing the machine has the correct dimensions (Fig.1).

The manufacturer declines any responsibility towards persons or objects, as well as for the proper operation of the machine, due to failure to follow the instructions given.

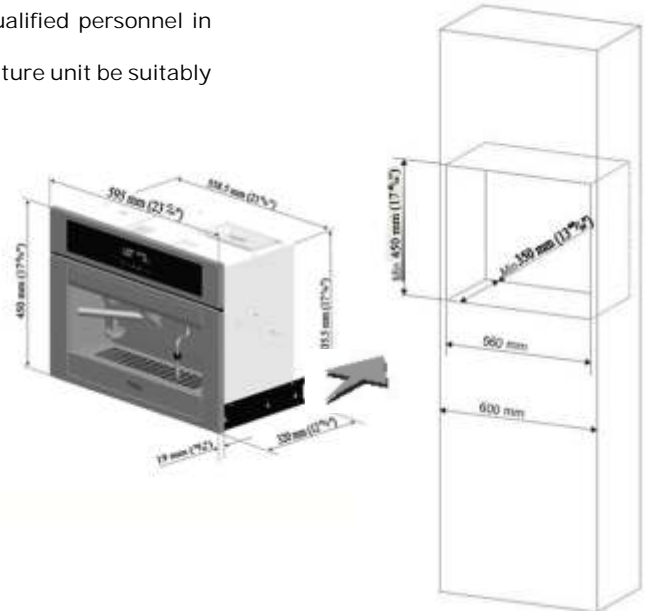

ATTENTION

Install the base so that the guide rails are perfectly vertical

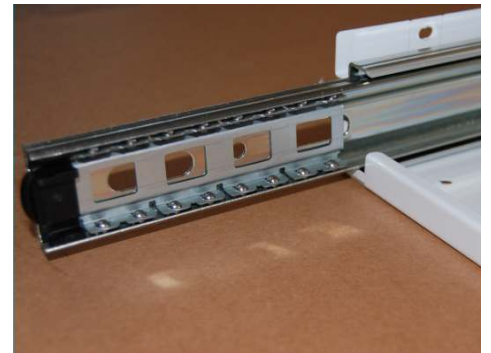

4) Before mounting the unit to the sliding rails, ensure that the bars with the sliding ball bearings are positioned at the front of the rail as shown in the image below. Failure to do this may result in damage to the sliding rails.



6) If you have to pull out the machine, lift the drawer and pull out.

- If you have to remove the machine from the base unhook it from the lateral guides using the levers, raising the lever of the right-hand guide and lowering the lever of the left-hand guide (2).



5) Mounting the machine to the base.

The machine has to fit correctly to the sliding rails otherwise damage may occur to the sliding rails and force out the ball bearings.

- Due to the weight of the machine it is recommended that this operation is carried out by two people.
- Position the unit to the sliding rails and slide back inside the kitchen cabinet housing. If any restriction is felt or it moves more easily on one side pull the machine out and ensure the sliding rails fit correctly.
- Once fitted correctly to the rails the machine will slide back smoothly and a "click" will be heard as the machine locks correctly to the sliding rails.
- Leave sufficient space to access and insert the power cord.
- Turn the power switch on the side of the unit to the ON position.
- Push the machine all the way back on its sliding rails to locate it fully within the cabinet housing.



PLUMBING (optional from factory)

• The installation of the appliance must be carried out exclusively by qualified personnel.

- Before connecting the coffee machine to the water mains, please insert the flow restrictor between the two rubber washers.

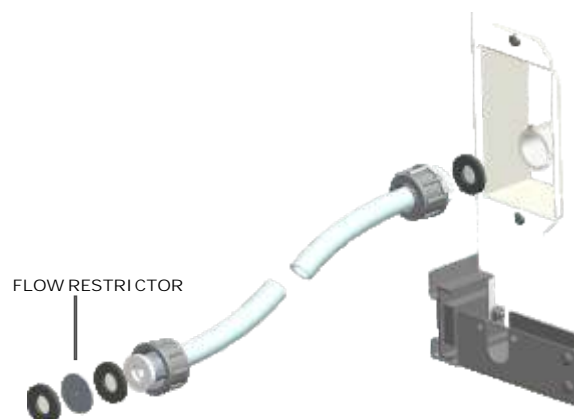

3 DESCRIPTION AND OPERATION

The coffee machine has only one water heater, for the steam, water and for the coffee. In this espresso machine the beans can remain in the grinder and only require grinding when needed. This provides the best aroma of the coffee because it is freshly ground. If the container used, glass or cup, has a smaller volume than the dosage programmed by the machine, coffee dispensing can be interrupted at any time by pressing key '12', allowing the user to decide on the preferred dose. The steam from the dispenser can also be used for pre-heating the cups.

TECHNICAL DATA

- Type: professional coffee machine
- Material: stainless steel 304
- Main colour: stainless steel
- Other colours available: on request
- Outside dimensions: H 455xW 595xD 320 mm
- Built in dimensions: H 450xW 560xD 350 mm
- Appliance weight: 25 Kg
- Package dimensions: H 550xW 700xD 455 mm
- Gross weight: 29 Kg
- Voltage: 220 V / 50/60 Hz
- Pump pressure: 15 bar
- Pump consumption: 48 watt
- Coffee and steam boiler consumption: 1000 W
- Grinder consumption: 100 W
- Maximum consumption: 1100 W
- Water tank capacity: 2,5 L
- Beans tank capacity: 350 g
- Coffee boiler heating time: 3 minutes

FRONT AND OVERALL VIEW

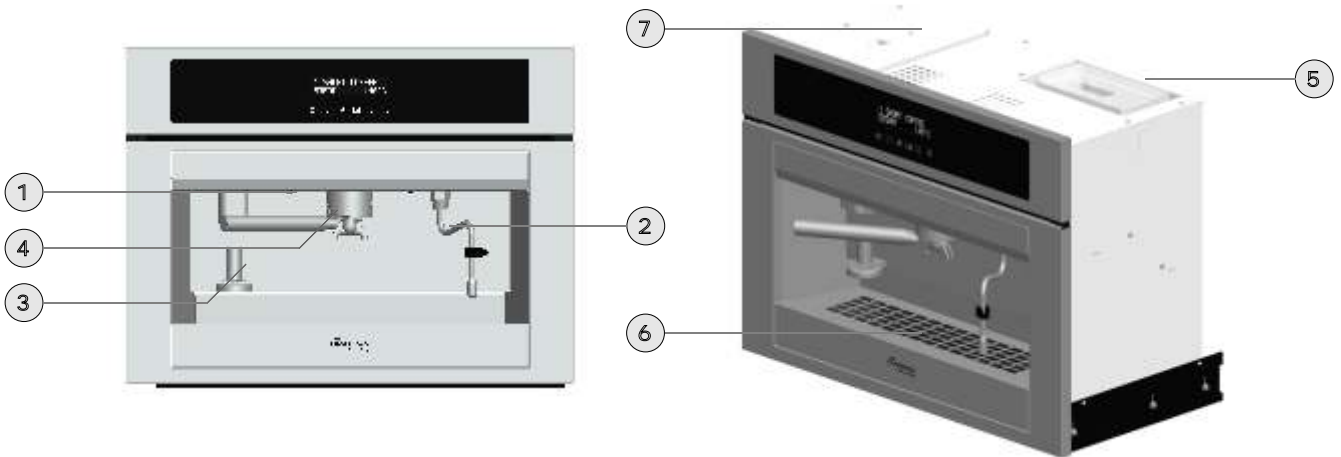

- 01. Lighting
- 02. Steam dispenser
- 03. Holder for grinding / coffee presser
- 04. Coffee dispenser
- 05. Water tank
- 06. Drip tray
- 07. Container for coffee beans
- 08. On/Off button
- 09. 1 cup/2 cup selector
- 10. Grinder
- 11. Short, medium or long coffee selector
- 12. Coffee dispensing button
- 13. Steam/Water selector
- 14. Display
- 15. Main switch
- 16. Grinder set

CONTROL BUTTONS AND DISPLAY PANEL

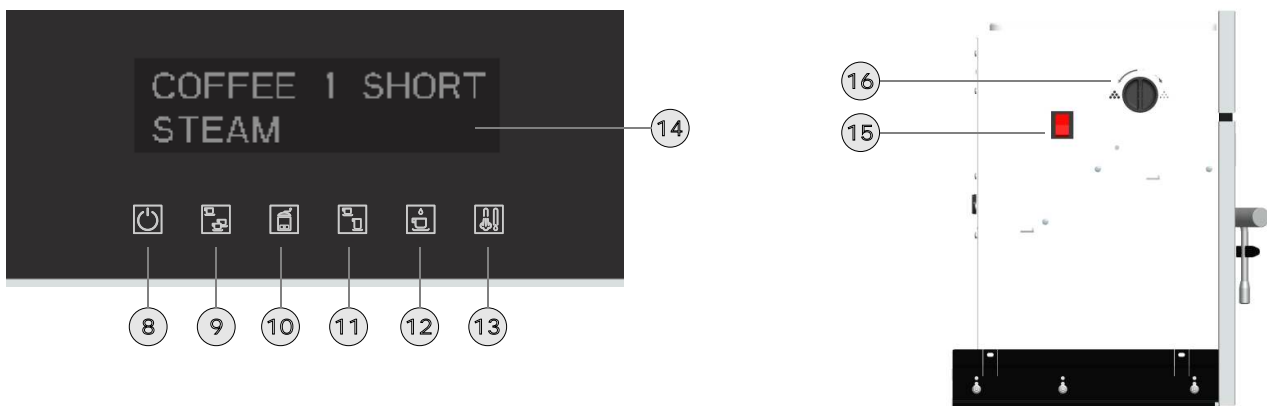

4 IMPORTANT INSTRUCTIONS FOR USE

SWITCH-ON

- Extract the machine by lifting the drawer and pulling it towards you.
- Fill the water tank and the coffee container following the instructions.
- Supply power to the machine using the main switch (15) located in the upper part of the right side of the machine.
- Close the machine.
- Switch on the machine using the key 

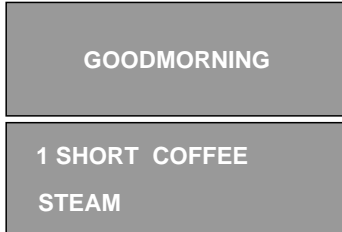

During the heating phase, the words COFFEE and STEAM/WATER (or WARMING) flash. The machine is ready for use only when they have stopped flashing. The display also shows the type of coffee selected (short/medium/long) as well as the choice of making one or two coffees at the same time.



If a failure is signalled, turn the main switch off and back on to help the water circuit to fill up.

FILLING THE WATER TANK

- To ensure the best result in making espresso, in addition to using good quality coffee, it is also essential to use good water. We therefore recommend emptying the water tank frequently and refilling it with fresh water. Avoid leaving the water in the tank for excessively long periods.

When the water tank is almost empty, the message " WATER MISSING " will appear on the display panel. Note: the tank can be removed for cleaning (see CARE AND CLEANING).

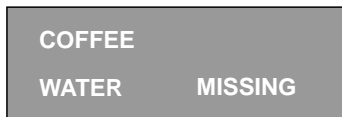

IMPORTANT: Use only drinkable water

- Open the machine by raising the drawer and pulling outward.
- Extract and fill the tank.
- Replace properly the water tank and close the machine.



FILLING THE COFFEE BEAN CONTAINER

- Fill the coffee bean container using only beans for espresso coffee. Any other substance, including ground coffee, can damage the coffee grinder. Do not use beans treated with caramel, sugar, or similar substances, instant coffee, or any beverage containing sugar. Sugar can damage the machine.

When the container is almost empty, the message " COFFEE MISSING " will appear on the display panel:

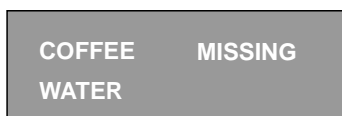

- Open the machine by raising the drawer and pulling outward.
- Remove the lid of the coffee bean container.
- Fill the container with beans up to 2 cm from the top.
- Put the lid back on the container.
- Close the machine.



SETTING 1 OR 2 COFFEE

With this machine you can prepare a single coffee or 2 coffees simultaneously.

Make your selection using the key 

SELECTING THE TYPE OF ESPRESSO

Using the key  you can select three types of espresso dose:

SHORT - MEDIUM - LONG

PREHEATING

Insert the portafilter and keep press the button 

and press 

The machine starts to warm up:

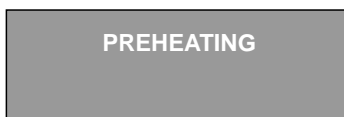



For a few seconds from the central group steam will start to come out. Once the process is completed, please empty the filter holder from any water residue.

Now the machine is properly heated and ready to dispense hot coffee.



ADJUSTING THE ESPRESSO DOSE

To change and memorize the quantity of coffee, proceed as follows:

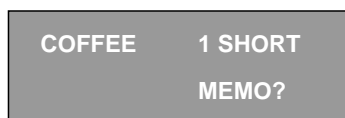
- Press the key  and release it, during the infusion, press and hold the key  until the desired quantity (coffee dose) is reached.



If you want to memorize the dosage of coffee just made, proceed as follows:

- To memorize, as soon as the infusion is finished, use the key  to select the type of coffee (short, medium, or long) on which to memorise the new setting.
- Press and hold the key  again until you hear the beep of confirmation. Now the new quantity of coffee is memorized and associated with the type of coffee selected.

PREPARING CAPPUCCINO

- Select the steam function using the key 
- Before positioning the container under the steam nozzle to flush out the water remaining in the pipes.
- Prepare a medium coffee in a cappuccino cup.
- Fill a jug milk with about 100 ml of milk. This is the quantity for preparing one cappuccino. We recommend preparing frothed milk for one cappuccino at a time.
- Introduce the steam nozzle into the milk container so that the spout is positioned on the bottom of the container (Fig. A).
- Press the steam button to release the steam and heat the milk for a few seconds.
- Important: Do not heat the milk excessively. Overheated milk no longer produces froth.
- After a few seconds, position the spout of the nozzle at the surface of the milk (Fig. B).
- When the desired froth is obtained release the steam button.
- Pour the milk delicately into the cup previously filled with coffee.



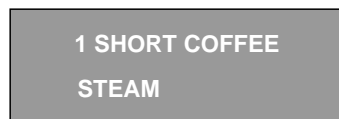

STEAM

- Switch on the steam for preparing steam using the key  and wait till the word "STEAM" has stopped flashing.





- Position the cup or other container under the nozzle.
- Press the steam button to dispense the steam 

WATER

- If you need hot water please hold the key  and  to change the «steam» function in «water» function.

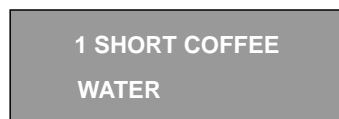
The display shows:



- Switch on the water for preparing water using the key  and wait till the word "WATER" has stopped flashing.
- Position the cup or other container under the nozzle.
- Press the steam/water button to dispense hot water

Warning! Danger of burning! The liquids that come out of the dispensers are extremely hot!

NOTE:

Always use the handle to move the steam/water spout!

DEACTIVATE STEAM AND WATER (CHILD LOCK)

Press and hold the key  and press 

till the display shows:

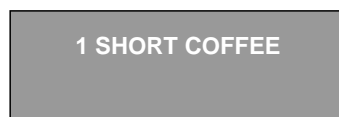

The functions «steam» and «water» are deactivated. Any hot liquid will not come out from the nozzle.

Your machine is extremely versatile. You can get a great espresso or other beverages using:

- coffee beans
- ground coffee
- single serving pods (for coffee or other beverages)
- compatible coffee capsules Lavazza Espresso point andilly, Nespresso and others with similar dimension (for coffee or other beverages)

COFFEE BEANS



- If the machine is used to grind the coffee beans contained in the tank:
- put the coffee dispenser on the holder for grinding;
- activate it by pressing the key  ; fill the coffee dispenser completely.





- please use the coffee press provided.



- press strongly the ground coffee inside.



- select one or two coffee by pressing 
- select short / medium / long coffee by pressing 



- insert the coffee dispenser into the central compartment through a pressure and rotation until it stops;
- press:  the machine starts to brew coffee.



- before using the machine again, please empty the coffee dispenser reversing the contents in the coffee grounds container.

GROUND COFFEE



- put the ground coffee inside the coffee dispenser,
- fill the coffee dispenser completely.





- please use the coffee press provided.



- press strongly the ground coffee inside.



- select one or two coffee by pressing 
- select short / medium / long coffee by pressing 



- insert the coffee dispenser into the central compartment through a pressure and rotation until it stops;
- press:  the machine starts to brew coffee.



- before using the machine again, please empty the coffee dispenser reversing the contents in the coffee grounds container.

SINGLE SERVING PODS (optional)



- the machine can be used with single serving pods (44 mm ESE).



- insert in the coffee dispenser the special adapter for single serving pods.



- press the pod into the filter.
- select short / medium / long coffee by pressing 



- insert the coffee dispenser into the central compartment using an upward pressure and rotation until it stops and press 
- the machine starts to brew coffee or other beverage.

COMPATIBLE COFFEE CAPSULES LAVAZZA ESPRESSO POINT & ILLY (optional)



- the machine can be used with compatible coffee capsules Lavazza Espresso Point, Illy, and others with similar dimensions.



- insert in the coffee dispenser the special adapter for these coffee capsules



- insert the selected capsule.
- select short / medium / long coffee by pressing 



- insert the coffee dispenser into the central compartment using an upward pressure and rotation until it stops and press 
- the machine starts to brew coffee or other beverage.

COMPATIBLE COFFEE CAPSULES NESPRESSO and others with similar dimensions (optional)



- the machine can be used with compatible coffee capsules Nespresso and others with similar dimensions.



- insert in the coffee dispenser the special adapter for these coffee capsules



- insert the selected capsule.
- select short / medium / long coffee by pressing 



- insert the coffee dispenser into the central compartment using an upward pressure and rotation until it stops and press 
- the machine starts to brew coffee or other beverage.

To remove the adapters from the coffee dispenser, tap the coffee dispenser on a wooden surface (such as a sturdy chopping board) to loosen them for removal. The adapters need to be tight in order to direct the water flow through the coffee. They will loosen slightly through regular use.

The brands Lavazza, Illy and Nespresso are registered trademarks of their respective companies. They are not the property of this company or anyone else connected to it. These marks and the reference of their models are mentioned only to indicate their compatibility with this machine.

5 OPERATION AND USE



PROGRAMMING THE MACHINE

The machine is ready to be used once the heating phase has completed, however there are additional advanced programmes which can be accessed if required.

Various functions can be adjusted and programmed, as indicated below: to enter programming mode, with the machine OFF press

the key  for 3 seconds until the display panel shows:





Use the keys   to select the functions to be programmed (these keys will allow you move up and down through the programme menu), which are, in order of appearance:

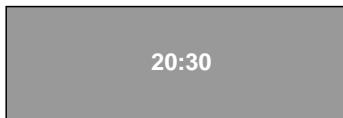

Pressing the key  the display panel shows:



Use the keys   to set the hour. Initially the two digits related to the hour flash.

After setting the hour, press the key  The two digits related to the minutes flash.



Set the minutes by pressing the keys  

To set AM or PM press the key  about 3 seconds.

AUTOMATIC SWITCH-ON

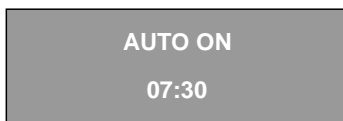
Press the key  and the display panel shows:



Use the keys   to set the time you want the machine to switch on automatically.

Your machine will be ready to dispense coffee at the time selected without waiting for the heater to warm up.

Automatic switch-on can be activated or de-activated by pressing



the key  (with the machine off).

The display will show an * after the clock time indication when the automatic switch-on function is activated.

AUTOMATIC SWITCH-OFF

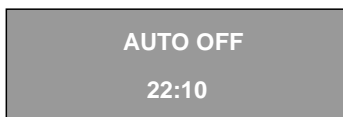
Press the key  and the display panel shows:





Use the keys   to set the time you want the machine to switch off automatically.

AUTO SHUT DOWN

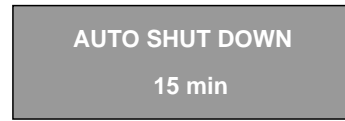
Press the key  and the display panel shows:





Use the keys   to set the minutes (15-30-45-60-75-90 min) after which the machine switches off automatically. 0=OFF.

POWER SAVING

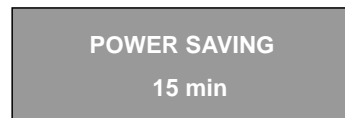
Press the key  and the display panel shows:



Use the keys   to set the minutes (15, 30, 45, 60, 75, 90 min) after which the machine goes into "energy savings" mode.

In this phase, the temperature of the heater is lowered to reduce consumption (at about 50°C).

Press the key  to restore the machine to a ready status quickly.

DISPLAY LANGUAGE

Press the key  and the display panel shows:





Use the keys   to select your language.

WATER HARDNESS

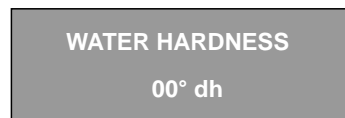
Press the key  and the display panel shows:



Use the keys   to set the hardness of the water after using the special measuring kit to establish the correct number (0,5,10,15,20,25° dh) to be entered.

5 grün/green/vert		0°dh/ 0.00°e/ 0°f
1 rot/red/rouge		5°dh/ 6.25°e/ 9°f
2 rot/red/rouge		10°dh/12.50°e/18°f
3 rot/red/rouge		15°dh/18.75°e/27°f
4 rot/red/rouge		20°dh/25.00°e/36°f
5 rot/red/rouge		25°dh/31.25°e/45°f

DESCALING



The display shows the number of litres of water that have been dispensed and the theoretical level of lime scale build-up expressed as a percentage (100% indicates that you need to carry out descaling).

This parameter is calculated based on the water hardness and the number of litres of water dispensed. The lime scale indicator will reset after a descaling cycle has been carried out.

COFFEE COUNTER

Press the key  and the display panel shows:





The display indicates the number of coffees that have been made since the first use.

GROUND COFFEE QUANTITY

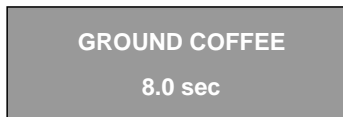
Press the key  and the display panel shows:



Using the keys   you can change the grinding time.

If you are not in the programming mode you can change the grinding time keeping the key  held until to obtain the desired amount of ground.



When you leave the key  the grinding stops and time is saved by the machine.

GRINDER SET



Slide the machine forward pulling it off and rotate the knob on the left side.



In order to have a significant change in grinding, one has to rotate the knob at least two rotations (counter clockwise for rough grinding and clockwise for fine grinding).

The maximum rotation is six full turns each way.

COFFEE TEMPERATURE

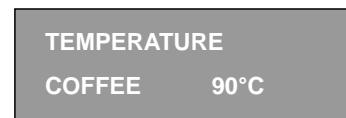
Press the key  and the display panel shows:



Using the keys   you can change and set the temperature.

Press the key  to exit the programming function.

6 CARE AND CLEANING

IMPORTANT: The container must be emptied regularly to prevent the formation of mould and bacteria.

- Open the drawer A.
- Remove the grille B.
- Extract and empty the coffee grounds container C and the water container D.
- Place the two containers and the grille back in their seats.
- Close the drawer.
- Now the machine is ready for use again.

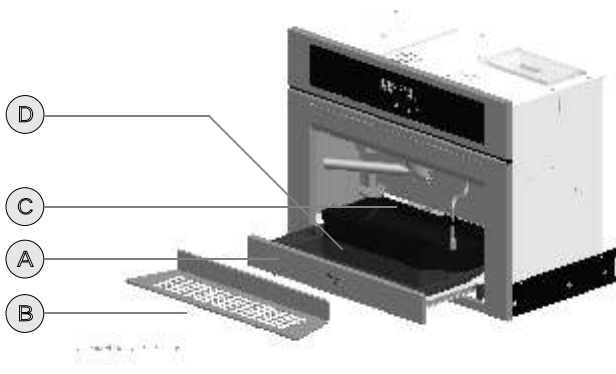

It is recommended to carry out a washing cycle

(just press button  without filling the coffee holder) on the unit every day before making the first cup of coffee (the machine warms up properly) and after dispensing last coffee (it keeps the filters clean).

The appliance must not be immersed in water or other liquids for cleaning.

Let the coffee machine cool down before proceeding with cleaning.

Danger of burning!

Do not use steam appliances for cleaning the machine.

Do not use any detergent substances containing soda, acids, or chlorides! These substances will ruin the surface of the machine.

Regular cleaning guarantees the efficient operation and long life of your espresso coffee machine.

Remove the grille and tray from the machine and clean both the front panel and the inside compartments with a soft sponge dampened with a sanitising detergent solution.

Dry with a soft cloth to avoid scratching.

WATER TANK

It is preferable to empty the water tank daily and refill it, when possible just before preparing coffee, with cold drinkable water.

Wash the water tank by hand using a sanitising detergent solution. If while washing the water tank the float level sensor should drop out of its rail, please slot it in again making sure that the magnet is in its lower position.

STEAM DISPENSER

Clean the steam dispenser with a soft sponge using only water, preferably hot water. To remove any incrustations, we recommend washing the components in the dishwasher. The steam spout can be unscrewed for washing in the dishwasher. When it is used for frothing milk, it is advisable to release some steam first to flush out any remaining residues of milk or froth.

7 DESCALING THE MACHINE

When the message "DESCALING" appears on the display with the machine off, it is time to descale your machine using specific products that are appropriate for coffee machines.

Attention – Very Important!



Do not use lemon-based products for descaling. These products contain citric acid, which in contact with calcium at high temperatures forms a chemical reaction, creating calcium citrate that could lead to the total obstruction of the water circuits.

Proceed as follows:

Open the drawer and remove the water from the tray and any coffee grounds from the container. Re-close the drawer without replacing the grille, and position the steam nozzle so that the water that comes out of it falls into the tray.

- Switch on the machine and wait till the word STEAM has stopped flashing.
- Switch off the machine and go into programming mode by

pressing the key  for 3 seconds until the displays shows "PROGRAMMING".

- Select the descaling function using the keys   and "DESCALING" appears on the display panel.

- Press and hold the two keys   together and then 

The machine prepares for descaling. When you hear the beep of confirmation, the message DESCALING STEP 01 appears on the display.

DESCALING STEP 01:

Fill the tank halfway full with the descaling product then press 

DESCALING STEP 02:

keep the button  pressed.

DESCALING STEP 03:

machine starts to delivery water from nozzles, keep the button  pressed till the end of the cycle.

DESCALING STEP 04:

empty and clean the water tank, then refill it with over 1 litre of fresh water, then press .

CLEANING STEP 05:

keep the button  pressed until 1 litre of water is dispensed from the machine, wait for the end of the cycle.

Fill the tank with water and wait until the coffee and water temperatures are reached.

The manufacturer declines all responsibility for any damage caused by failure to carry out descaling.

IMPORTANT: machine provided with direct water supply must be plumbed according to regional rules, with main tap, retaining valve, 150micron filter.

8 TROUBLE - SHOOTING

The machine does not switch on

- The main switch is off
- No electricity

The coffee does not come out or comes out in slow drips

- Coffee grind too fine (increase the grinder set)
- Coffee machine pipes obstructed: - press  without coffee dispenser, some water comes out from the central part.
- or do a new descaling cycle.

The coffee comes out too fast and is not creamy

- Coffee too old
- Coffee too thick (decrease the grinder set)
- Chose a more creamy blend

The milk froth does not form

- Check that the flow of steam is suitable
- Do not heat the milk excessively

Loud noise of the pump when dispensing

- Keep the STEAM button pressed till it starts or press  without coffee dispenser

The machine does not go on PROGRAMMING mode

- To create mass by touching the handle of the machine and keep press on/off button

Sensitivity of touch control

- In case steam should spread onto touch control just dry it with a soft cloth or restart the machine by the main red switch on the right.

AUTO-DIAGNOSTICS

The electronic circuits manage and recognize various alarms and operating anomalies. These are indicated on the display panel.

ALARMS

The display panel could shows these alarms signs:





Solution: it is a generic alarm; before calling the technical service, please try to switch off and switch on the machine.

WATER PRESSURE

1

Solution: before calling the technical service,

check the water tank and press the key  and reset the machine by pressing the key 

GRINDER LOCK

2

Solution: before calling the technical service, check for the presence of foreign bodies in the grinder (stones, impurities, other foreign bodies). If necessary use a vacuum cleaner to suck up all the beans.

Then reset the machine by pressing the key 

SERVICE

3

Solution: there is a problem with the coffee heater; before calling the technical service, please try to switch off and switch on the machine.

If the display shows:

MAINTENANCE

CALL SERVICE

For any operating anomaly, contact your nearest service center.

9 DISPOSAL OF ELECTRICAL APPLIANCES



This product complies with EU WEEE Directive (2012/19/EU). This product bears a classification symbol for waste electrical and electronic equipment (WEEE). This product has been manufactured with high quality parts and materials which can be reused and are suitable for recycling. Do not dispose of the waste product with normal domestic and other wastes at the end of its service life. Take it to the collection center for the recycling of electrical and electronic equipment. Please consult your local authorities to learn about these collection centers.

Compliance with RoHS Directive: The product you have purchased complies with EU RoHS Directive (2011/65/EU). It does not contain harmful and prohibited materials specified in the Directive. **Package information:** Packaging materials of the product are manufactured from recyclable materials in accordance with our National Environment Regulations. Do not dispose of the packaging materials together with the domestic or other wastes. Take them to the packaging material collection points designated by the local authorities.